

# AC SERIES COMPRESSION LOAD CELLS

## COMPONENTS + SPECIFICATIONS GUIDE

Cardinal Scale's AC series load cells and electronics provide everything you need for a vehicle scale, minus the weighbridge.

3502-D429-0A



3502-D596-1A

225



3502-D617-1A













(8) AC-100K



LEGAL FOR TRADE



**Cardinal**  
www.CardinalScale.com

	MODEL #	DESCRIPTION
	AC-50K	22,700 kg / 50,000 lb capacity analog compression load cell
	AC-100K	45,000 kg / 100,000 lb capacity analog compression load cell
	3502-D596-1A	Universal 8 load cell analog junction box
	3502-D617-1A	8 load cell transient protection junction box
	3502-D596-0A	Universal 12 load cell analog junction box
	3502-D617-0A	12 load cell transient protection junction box
	3502-D429-0A	Pull junction box
	0146-B020-08	Load cell cup retainer plate (non-painted)
	RC3-KIT	Load cell cups and anti-rotation mounting hardware for using AC or DC load cells to replace 30 or 40 metric ton Flintec RC3 load cells
	225	225 Navigator digital weight indicator (OIML and NTEP approved)
	825	825 Spectrum digital weight indicator (OIML and NTEP approved)

# AAC SERIES COMPRESSION LOAD CELLS

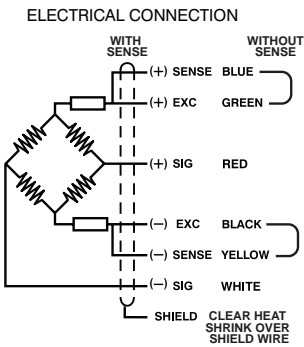
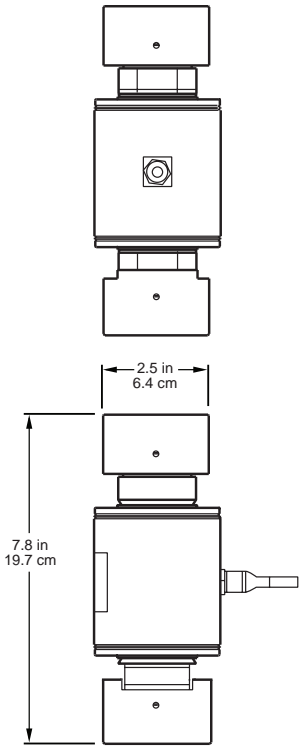

## SPECIFICATIONS

Capacity	AC-50K	22,700 kg / 50,000 lb
	AC-100K	45,000 kg / 100,000 lb
Rated Output	2mV/V at rated capacity	
Output Resistance	1005±5	
Input Resistance	1150±50	
Accuracy Class	4,000 n. OIML / 10,000 NTEP	
Minimum Dead Load	0%Ln	
Service Load	120%Ln	
Safe Load Limit	200% Rated Capacity	
Total Error	< ±0.017%Sn	
Repeatability Error	< ±0.015%Sn	
Temperature Effect on Zero	< ±0.01%Sn/5 °C	
Temperature Effect on Sensitivity	< ±0.006 %Sn/5 °C	
Creep Error (30 minutes)	< ±0.016 %Sn	
Temperature Compensation	-10°C to + 40°C	
Temperature Limits	-50°C to + 70°C	
Nominal Sensitivity	2mV/V	
Nominal Input Voltage	10V	
Maximum Input Voltage	15V	
Input Impedance	1150±50Ω	
Output Impedance	1005±5Ω	
No Load Output	±2%Sn	
Insulation Resistance	> 5000 Ω	
Maximum Deflection	0.6-1mm	
Protection Class	IP69K	
NTEP Certification Number	17-123	
OIML Certification Number	2000-A-GB1-18.03	

Cardinal Scale reserves the right to improve, enhance, or modify features and specifications without prior notice.

**SOLD BY:**

**Cardinal**  
Cardinal Scale Manufacturing Co.

203 E. Daugerty, Webb City, MO 64870 USA  
Ph: 417-673-4631 or 800-441-4237 • Fax: 417-673-2153  
[www.CardinalScale.com](http://www.CardinalScale.com)

Mobile: [m.cardinalscale.com](http://m.cardinalscale.com)